

ZAXIS GI series

TATA HITACHI

Reliable solutions

ZAXIS 400_{MTH}



HYDRAULIC EXCAVATOR

Engine Rated Power : 184 kW (250 PS)
Operating Weight : 37,100 - 37,600 kg
Backhoe Bucket : ISO Heaped : 1.3 - 2.5 m³

NEW ZAXIS

Now, with the Power of GI

A ZAXIS hallmark – industry-leading hydraulic technology, and performance no other can beat. The New ZAXIS-GI Series Excavators provide reliable solutions through: great fuel economy, better speed of front attachments and easy operations. The advanced hydraulic system and engine in the New ZAXIS GI Series are the hallmark of our technological prowess and expertise.

The New ZAXIS-GI Series features the key benefits of high power, high fuel efficiency and high durability, all of which serve to ensure the highest return on you immanent.



Pursuits of Performance and Durability

Page 4-5

- MTH Undercarriage (Mighty Track – Heavy Duty version)
- Rock-solid, durable front attachment
- Durable, reliable Engine



Enhanced Operator Comfort

Page 8-9

- Robust cab
- New, easy-to-use multifunctional monitor
- Comfortable operating environment
- Suspension Seat - Designed for Comfort



Tata Hitachi Support Chain

Page 12-13

- Remote Fleet Management with Global e-Service
- Monitor your machines closely with ConSite
- Parts and Service



More Production with Less Fuel

Page 6-7

- Powerful fast and smooth combined operation with HIOS* III hydraulics
- Powerful Lifting Operation
- Enhanced Power Boost
- Boosted Swing Torque
- Exceptional Fuel Economy
- More Fuel Reduction in the ECO mode

*Human & Intelligent Operation System



Simplified Maintenance

Page 10-11

- Dust-Proof Indoor Net
- Grouped Remote Inspection Points
- Rigid, Robust Body
- Electric Fuel Refilling Pump
- Low Life Cycle Costs



Variants

Page 14-15

- Quarry
- Standard



Pursuits of Performance and Durability

State-of-the art R&D and Quality Control

Tata Hitachi is known for its technological prowess and product performance. The R&D Division has a track record of excellent design, stress analysis expertise using CAE system, and an abundant production data base. What's more, a large-scale durability test field allows for a series of stringent testing of new machines.



MTH Undercarriage (Mighty Track – Heavy Duty version)

The ZX400MTH machine comes with a MTH undercarriage which offers unmatched ruggedness, stability and performance. This MTH undercarriage comprising the reinforced track frame, track chains, rollers, idlers, track adjusters and travel devices are of the 45 ton class of excavators. Hence, the undercarriage gives exceptional strength and durability for your machine.

Integrated track adjusters increase durability and absorb impacts to crawlers.



45 Ton class heavy duty track frame



Track guard

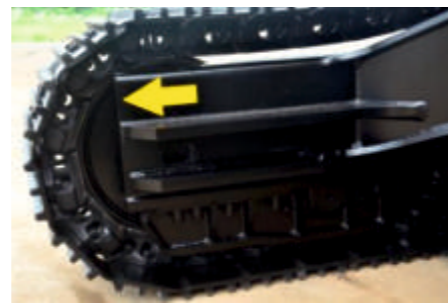

Reinforcement at idler side

- The track frame is given additional reinforcement on the idler side to provide extra rigidity to prolong the life and performance of the moving track parts.
- Specially designed two piece track guard functions to keep the track chains in place.
- The grease holes for the track adjusters have been repositioned so as to reduce dirt accumulation.



Rock-Solid, Durable Front Attachment

The boom top and bottom are strengthened using higher grade steel and larger size bosses. The boom and arm have been strengthened by increasing the cross section and by using thicker steel plates.

Boom and arm joints incorporate steel bushings to enhance durability. Special flange type bushes used in the arm- bucket joint ensures there is no direct rubbing of the bosses thereby increasing the life of pins and joints substantially.

A reinforced resin thrust plate mounted on the bucket pin helps reduce rubbing noise. Arm cylinder and boom cylinders (rod extend ends) cushion shocks at stroke end to cut noise and extend service life. Joint pins at the front attachment are tightly fit to reduce vibration and noise.

Reinforced Front Attachment (Boom / Arm)

Thickened steel plates, damage prevention plate square bars

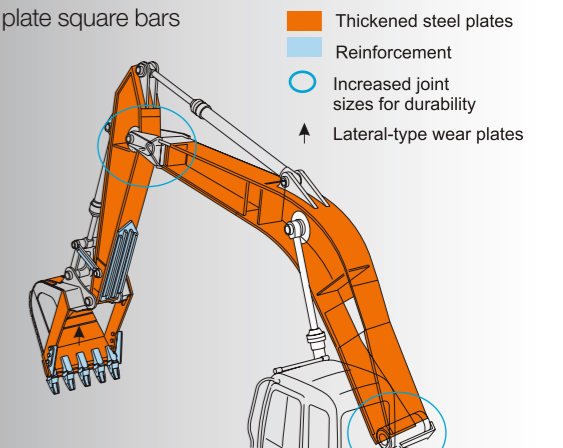

Durable, Reliable Engine

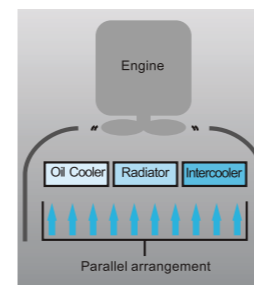

The engine used in Zaxis400MTH is proven with impressive durability at countless tough job sites around the world. The engine has a rugged design with direct fuel injection system – most suitable for Indian conditions – and an elaborate governor.

The engine complies with EU stage II and US EPA

Tier 2 emission regulations. The engine is known for its smooth power delivery, reliable performance, great life and high maintainability. The engine cover has a wider air suction area and radiators are arranged in parallel for efficient cooling. This parallel arrangement also facilitates their cleaning.

More Production with Less Fuel

Powerful fast and smooth combined operation with HIOS* III hydraulics

Operating speed increases with less fuel consumption thanks to the HIOS* III hydraulic system, developed using industry-leading hydraulic technologies and a wealth of experience. Actuators work quickly by boom weight, without needing a regenerative circuit and pressure oil.

Hydraulic boosting system

Arm roll-in speed increases by combined flow from arm and boom cylinders through regenerative valves for productive excavation.

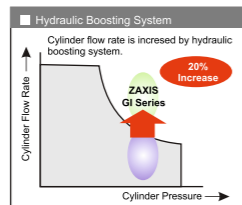

Enhanced boom recirculation system

Arm speed increases by boom weight during boom lowering, without needing pressure oil from the pump. That is, arm circuit flow is increased for higher arm speed, resulting in faster cycle times for quicker loading operations.

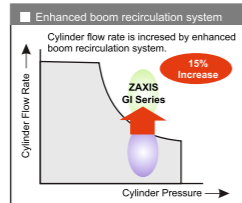

*Human & Intelligent Operation System

Powerful Lifting Operation

The Auto Power Lift mode, which automatically surges lifting force by 10% when needed, allows for powerful lifting of buried concrete pipes or sheathing sheets.

Enhanced Power Boost

The Power Boost mode allows the operator to surge 10% more digging force for powerful excavation by pressing a button on the control lever.

Boosted Swing Torque

Allows for powerful wall cutting with the bucket, and smooth swing operation on slope.



Exceptional Fuel Economy

The new ZAXIS-GI Series uses the advanced HIOS* III hydraulic system and engine control system to maximise output while offering exceptional fuel economy while reducing CO2 emissions.

More Fuel Reduction in the ECO mode

The ECO mode, a new economical mode, can further cut fuel consumption compared to the PWR mode, without sacrificing digging speed, by optimal matching of operations.

*Human & Intelligent Operation System

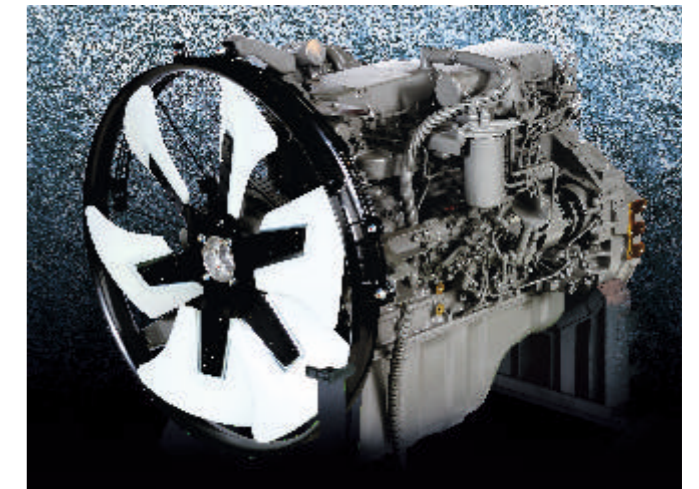

Enhanced Operator Comfort



Ergonomic, roomy, space and comfortable operator cabin

Robust Cab

The robust cab, meeting the OPG (Top Guard Level 1), protects the operator from falling objects. The pilot control shut-off lever is provided with a neutral engine start system that permits engine starting only when the pilot control shut-off lever is in lock position.

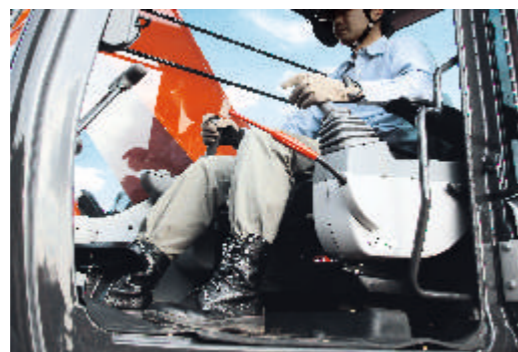

Comfortable working posture



Ergonomically placed monitor



Wide entry space for easy access

Comfortable Operating Environment

The cabin offers exceptional comfort and confidence with plenty of leg space and excellent visibility. The new compact console is designed to provide greater leg space. The new door pillar is shifted rearward by 70 mm to widen the entry space for easy access into the cabin.

The front window can be easily removed and stored overhead using slide rails. The overhead window is operable for ventilation.

Cabin guard is provided as a standard fitment.

Ample air conditioner vents are located strategically for uniform air circulation inside the cab. The control panel and control levers are arranged within easy reach of the operator. AM/FM radio and two speakers are available for a long work day with less fatigue. All these designs focus on operator comfort.



Easy to use monitor



Ergonomic control panel



Large storage space

Suspension Seat - Designed for Comfort

The Ergonomically designed suspension seat is fitted with a headrest and arm rests for operator comfort. The seat can be adjusted in multiple ways, sliding and reclining, to suit operator's size and preferences.

The seat can slide rearward by 40 mm more for added leg space.



Simplified Maintenance



Easily detachable dust-proof indoor net



Ground level inspection made easy

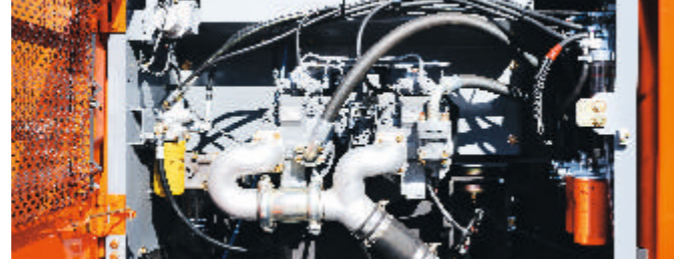

Grouped remote filters and inspection points

Dust-Proof Indoor Net

A dust-proof indoor net, provided at the front of the radiator, can be easily removed and cleaned with compressed air. At the rear of the radiator, air blowing can be done through a one-touch open cover. The air condenser is openable for easy cleaning at its rear.

Grouped Remote Inspection Points

Service points are concentrated inside left and right covers that are readily accessible from ground level for convenient servicing and inspection, including water draining from the fuel tank, replenishment of coolant, and replacement of filters. The fuel tank is anti-corrosion coated on its inside, and has a large cleaning port at the bottom. These wise designs effectively keep fuel clean and satellite easy servicing. Handrail is provided at a convenient location on the upperstructure. Slip-resistant plates are provided for safety during maintenance.



Rigid, Robust Body

Side frame tops of the undercarriage are sloped to let muck slide away. Track adjuster greasing ports are repositioned for easier lubrication and are well protected from muck packing.



Adjuster greasing hole repositioned to reduce dirt accumulation

Electric Fuel Refilling Pump

An electric fuel refilling pump is provided for conveniently filling fuel directly into the tank at the press of a button.

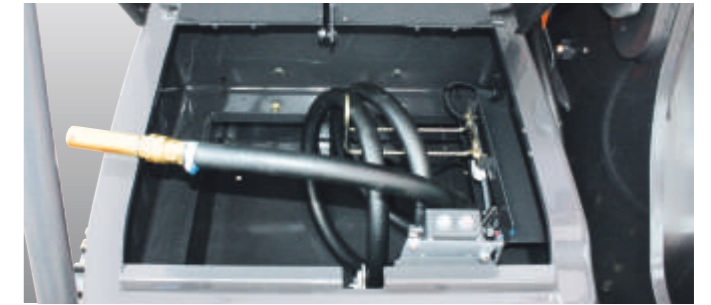

Electric fuel refilling pump



Utility space and radiators

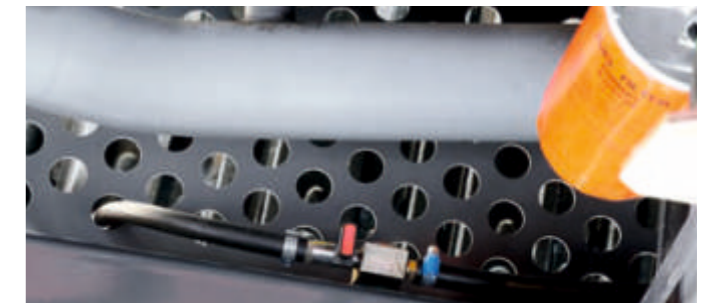

Fuel tank water drainage cock

Low Life Cycle Costs

Service intervals are long enough to slash maintenance costs.

Consumables

- Engine Oil : 500 h
- Engine Oil Filter : 500 h
- Hydraulic Oil : 5 000 h
- Hydraulic Oil Filter : 1 000 h
- Fuel Filter : 250 h



Note: Periodic inspection is required to check oil contamination.

Tata Hitachi Support Chain

A full customer support system offered on buying a Tata Hitachi GI Series machine.



Remote Fleet Management with Global e-Service

Easy access to On-Site Machines through the internet

Global e Service is a convenient and simple system designed to give you valuable information regarding the operations, maintenance, system parameters and alarms of your machines from the convenience of your office. This system can be configured to give you a customised dashboard of the vital parameters that you would like to monitor, to increase productivity and reduce the downtime of your fleet.

The operating data and logs are sent to our servers for processing and then to customers and dealers around the world. This system is available 24 hours a day, all the year round and can be viewed on your laptops and mobile devices through the Internet.

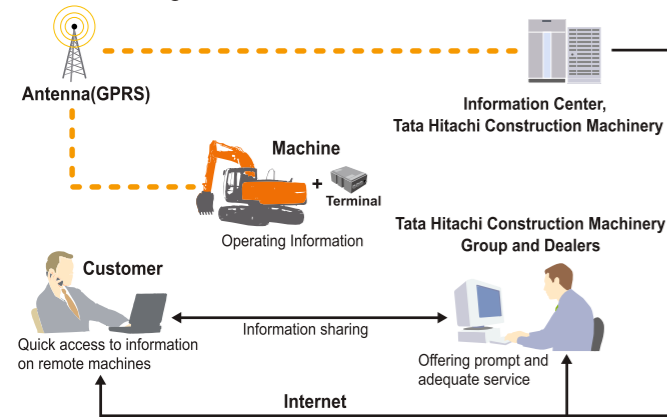

Note: In Some Regions, Global e-Service may not be Available due to Local Regulations.

Main Features of Global e-Service

Global e Service provides easy access to a machine on site conveying operating information and log, including daily operating hours, operations, fuel levels, location, itemised maintenance scheduling, machine's technical parameters and alarm history.



Operation

- Working site of customer machine can be determined.
- Route to working site of customer machine can be determined also.

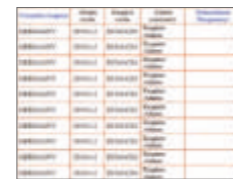

Alarm function

Information of alarms as causes of machine failures can be received in real time.

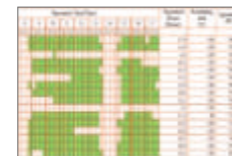

Hour meter / Daily report

Daily machine operation hours and remaining fuel can be determined.

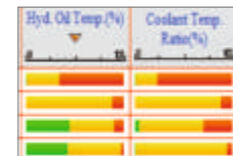

Operation information

Hydraulic oil temperature, swing hours and other data are determined.

We make IT work



- ✓ Minimise downtime
- ✓ Support your business

The reports can be viewed on laptops, desktop computers, smart phones & tablets.

The calendar's format allows you to see the daily operation times of your machine with ease. This report helps you analyse the operation trend of each machine.

The daily operation report shows in detail when the machine is operating and idle time, which is represented by different colours in the 24-hour timeline.

Monitor your machines closely with ConSite

Data Services



ConSite is a consolidated solution service that links you to your machines on the job site.

Through this system, we present your machine's key operational data with meaningful insights by tapping into Tata Hitachi's vast experience and database. There are two kinds of report services:

- Consolidated monthly operation reports with advice via email.
- Alarm or emergency notifications via email.

These two reports allow you to visualise the operation status of your machine, improve the efficiency of machine management and work closer with Tata Hitachi.

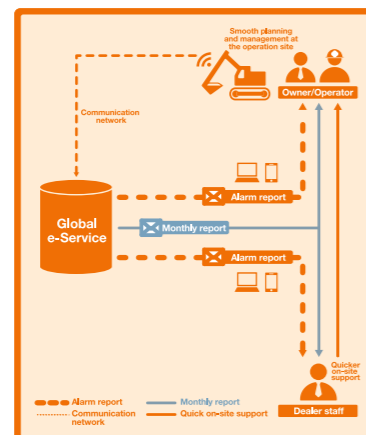

A. Monthly Report

A Detailed monthly operational report helps you to analyse and improve the operational efficiency of your machine.

Key Items included in the report:

- Status of parameters affecting fuel economy.
- Part wise operations time
- Recommended action

B. Alarm Report

If there is an alarm triggered in the machine and the problem requires urgent attention to prevent downtime, an emergency alarm report will be sent to the registered email addresses so that necessary measures can be taken. This information also flows to your authorised service representatives for smoother coordination and to reduce your machine's downtime.

Key items included in the report:

- Machine identification with hour meter details
- Alarm code / name
- Recommended action

Parts and Service

Parts

Genuine Tata Hitachi Parts

Genuine Tata Hitachi parts meet our stringent quality standards. These parts are guaranteed to perform and are backed by Tata Hitachi's warranty. The use of genuine Tata Hitachi parts including all filters and lubricants will slash your running costs and extend your machine's life.

Ground Engaging Tools (GETs)

Tata Hitachi provides an array of Ground Engaging tools developed and built for a variety of applications. Using high quality and well maintained GETs will help you get optimum performance.

Service

With our wide network across India, Tata Hitachi strives to offer you a superior service and support experience. The GI series machines are serviced by technicians and engineers specially trained to take good care of your machines. With a combination of our reach and skilled personnel, we aim to increase the uptime of your machines.

Diagnostic Tools – Maintenance Pro

Apart from operational information, Tata Hitachi's Maintenance Pro can diagnose machine faults & assist in quick restoration of the machine.



The photos above show machine images at work, which include machines other than ZAXIS 400MTH

ZAXIS 400MTH



ZAXIS 400MTH

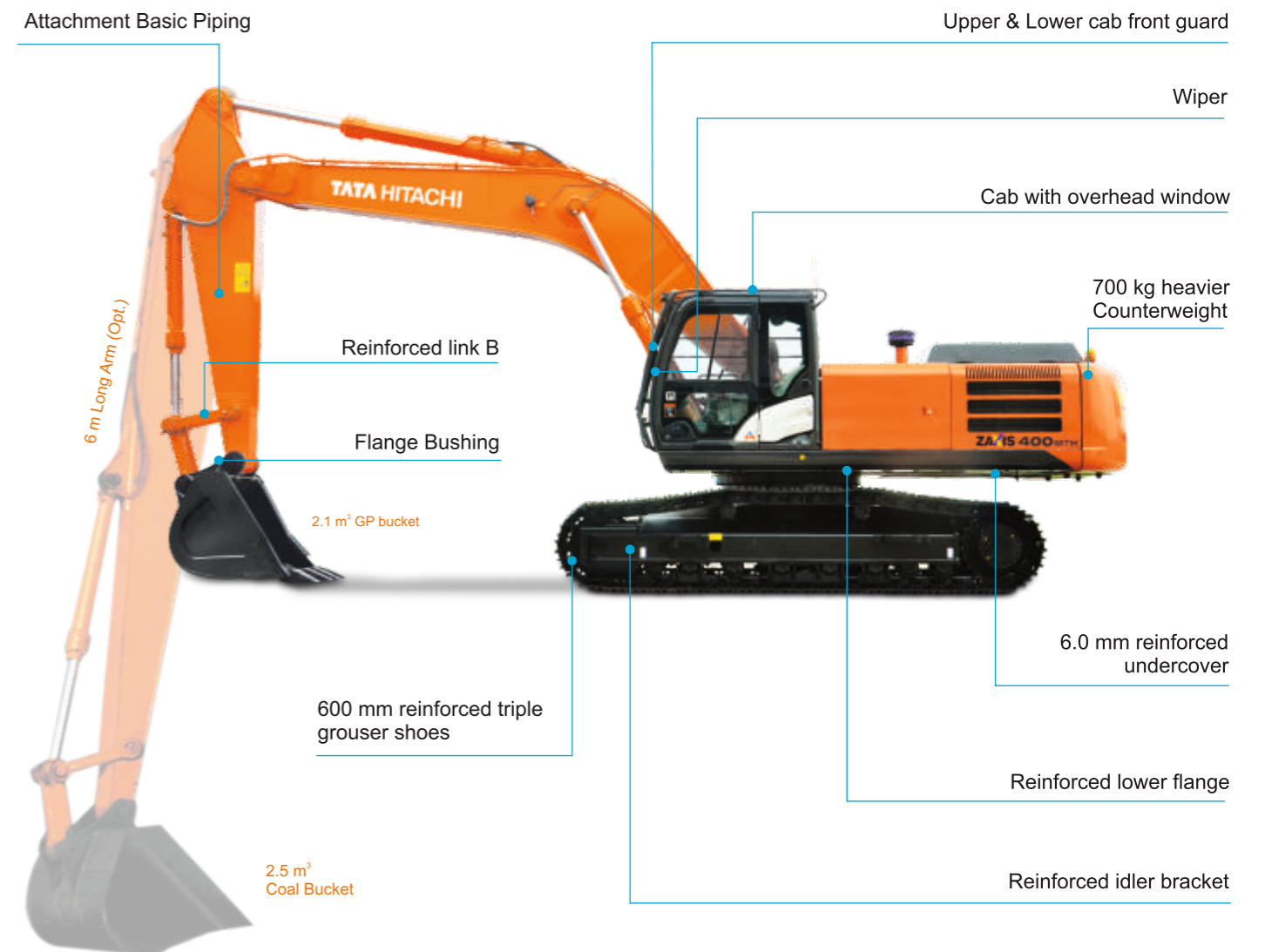

SPECIFICATIONS

ENGINE

Model	ISUZU AA-6HK1X
Type	4-cycle water-cooled, direct injection
Aspiration	Turbocharged, inter cooled
No. of cylinders	6
Rated power	
ISO 9249, net	184 kW (250 PS) @ 2000 rpm
SAE J1349, net	184 kW (250 PS) @ 2000 rpm
Maximum torque	873 Nm (89.0 kgfm) @ 1700 rpm
Piston displacement ..	7.790 L
Bore and stroke	115 mm x 125 mm
Batteries	2 x 12 V / 128 Ah

HYDRAULIC SYSTEM

Hydraulic Pumps

Main pumps	2 variable displacement axial piston pumps
Maximum oil flow ..	2 x 279 L/min
Pilot pump	1 gear pump
Maximum oil flow ..	32.8 L/min

Hydraulic Motors

Travel	2 variable displacement axial piston motors
Swing	1 axial piston motor

Relief Valve Settings

Implement circuit	350 kgf/cm ² (34.3 MPa)
Swing circuit	330 kgf/cm ² (32.4 MPa)
Travel circuit	355 kgf/cm ² (34.8 MPa)
Pilot circuit	40 kgf/cm ² (3.9 MPa)
Power boost	388 kgf/cm ² (38.0 MPa)

Hydraulic Cylinders

	Quantity	Bore	Rod diameter
Boom	2	145 mm	100 mm
Arm	1	170 mm	115 mm
Bucket	1	140 mm	95 mm

UPPERSTRUCTURE

Revolving Frame

D-section frame skirt for resistance to deformation.

Swing Device

Axial piston motor with planetary reduction gear is bathed in oil. Swing circle is single-row. Swing parking brake is spring-set/hydraulic-released disc type.

Swing speed	10.7 min ⁻¹ (rpm)
Swing torque	120 kNm (12 200 kgfm)

BACKHOE ATTACHMENTS

Capacity	Width		No. of teeth	Weight	Density of material handled (Kg/m ³)	
	Without Side Cutters	With Side Cutters			2.66 m	6m
ISO Heaped						
1.3	1300	1315	4	1580	G&M	-
1.5	1376	-	5	1665	2000	-
2.1	1570	1625	5	1949	1600	-
2.5	2197	-	-	1089	-	800
Block Handling Bucket	1355	-	4	1802	G&M	-

Operator's Cab

Independent spacious cab, 1 005 mm wide by 1 675 mm high, conforming to ISO* Standards.

* International Organization for Standardization

UNDERCARRIAGE

Tracks

Heat-treated connecting pins with dirt seals. Hydraulic (grease) track adjusters with shock-absorbing recoil springs.

Numbers of Rollers and Shoes on Each Side

Upper rollers	2
Lower rollers	8
Track shoes	49
Track guards	3

Travel Device

Each track is driven by 2-speed axial piston motor. Parking brake is spring-set/hydraulic-released disc type. Automatic transmission system: High-Low.

Travel speeds	High : 0 to 5.1 km/h
	Low : 0 to 2.8 km/h

Maximum traction force 400 kN (40 790 kgf)

Gradeability 70% (35 degree) continuous

SERVICE REFILL CAPACITIES

Fuel tank	630.0 L
Engine coolant	35.0 L
Engine oil	36.0 L
Swing device	15.7 L
Travel device (each side)	11 L
Hydraulic system	340.0 L
Hydraulic oil tank	180.0 L

OPERATING WEIGHT AND GROUND PRESSURE

Shoe Type	Shoe Width	Arm Length	ZAXIS 370LCH	
			KG	KPa (kgf/cm ²)
Reinforced Triple Grouser	600 mm	2.66 m	37100	68.6 (0.70)
	600 mm	6 m	37600	69.9 (0.71)

BUCKET AND ARM DIGGING FORCES

Arm Length	2.66m
Bucket Digging force* ISO	246 kN
Bucket Digging force* SAE PCSA	214 kN
Arm Crowd force* ISO	222 kN
Arm Crowd force* SAE : PCSA	213 kN

SPECIFICATIONS

WORKING RANGES

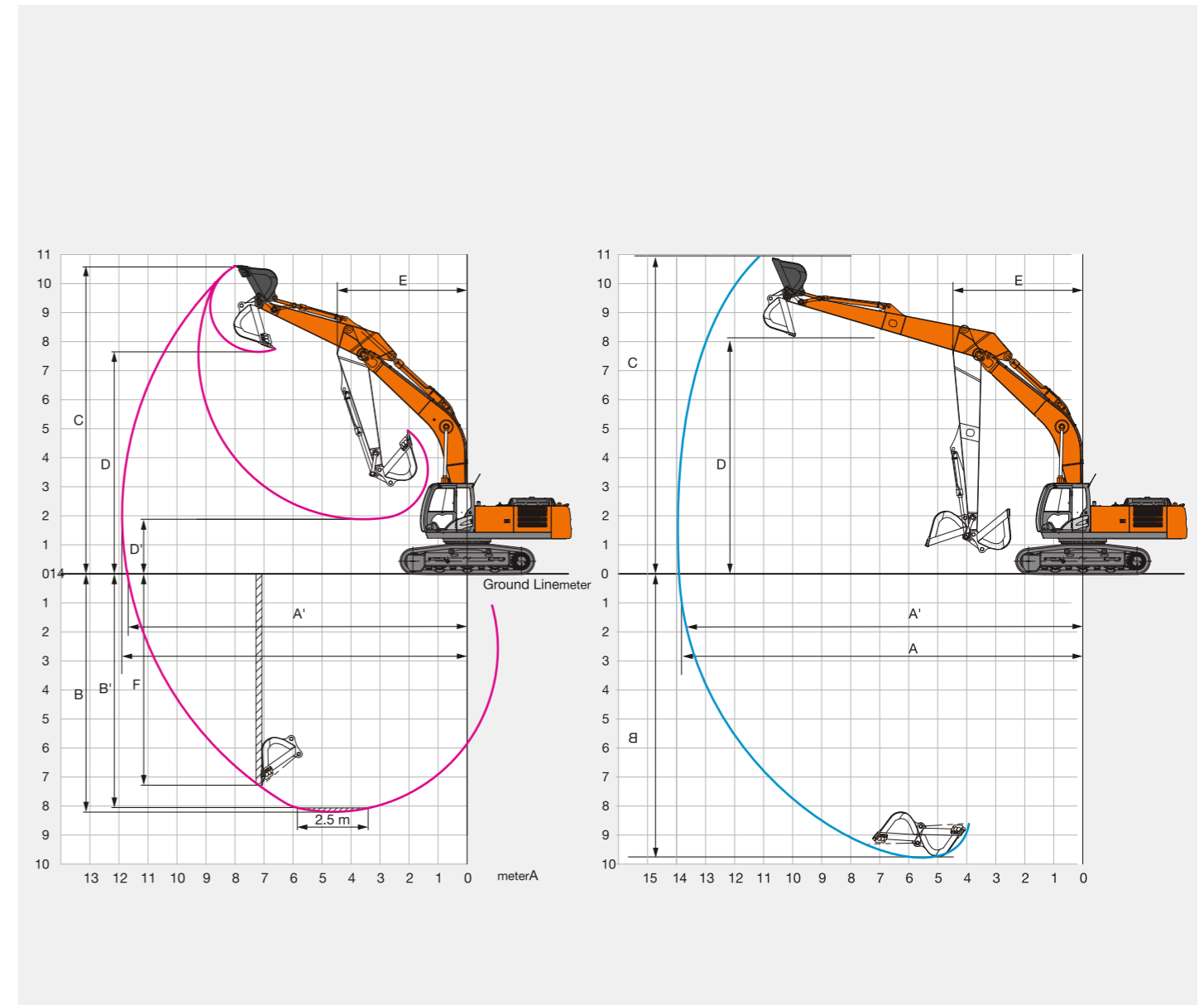

Arm length		2.66 m	6.0 m
A	Max. digging reach	10 570	13 190
A'	Max. digging reach (on ground)	10 350	13 020
B	Max. digging depth	6 800	9 920
B'	Max. digging depth for 2.5 m level	6 600	-
C	Max. cutting height	10 070	10 680
D	Max. dumping height	6 980	8 020
D'	Min. dumping height	3 250	-
E	Min. swing radius	4 610	4 440
F	Max. vertical wall digging depth	5 500	-

SPECIFICATIONS

DIMENSIONS

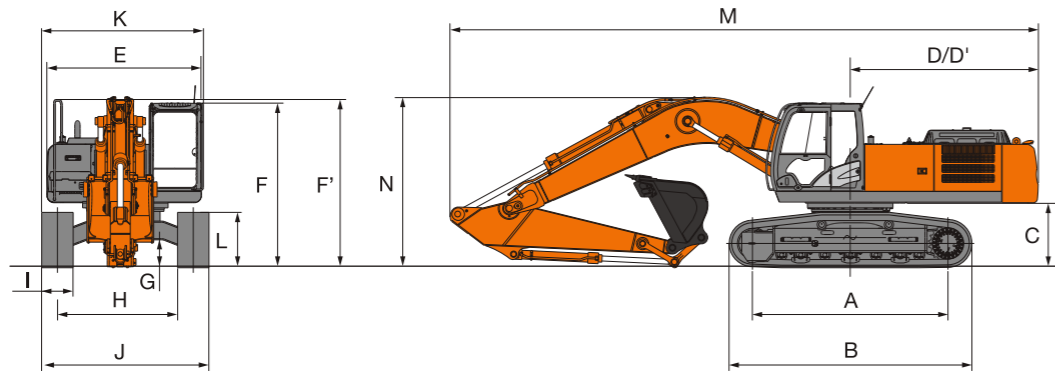

Unit: mm

	ZX400MTH	ZX400MTH
A	Distance between tumblers	4 040
B	Undercarriage length	5 040
*C	Counterweight clearance	1 183
D	Rear-end swing radius	3 590
D'	Rear-end length	3 590
E	Overall width of upperstructure	2 980
F	Overall height of cab	3 190
F'	Overall height of upperstructure	3 300
*G	Min. ground clearance	495
H	Track gauge	2 740
I	Track shoe width	G 600
J	Undercarriage width	3 340
K	Overall width	3 446
*L	Track height with triple grouser shoes	1 150
M	Overall length	11 350
	With 2.66 m arm	11 350
N	Overall height of boom	3 470
	With 2.66 m arm	3 470

* Excluding track shoe lug G: Triple grouser shoe

LIFTING CAPACITIES

ZAXIS400MTH LIFTING CAPACITIES (Without Bucket)

Conditions	Load point height m	Load radius m										At Max Reach				
		1.5m		3m		4.5m		6.0m		7.5m		meter				
Boom 6.40m Arm 2.66m Counterweight 6 900 Kg Shoe 600mm	6.0															
	4.5							*8930	*8930	*8224	7579	*8154	6755	8.010		
	3.0							*12952	*12952	*10062	*10062	*8662	7355	*8150	5895	8.568
								*15870	14739	*11390	9768	*9299	7060	8180	5460	8.868
	1.5									*12431	9273	*9854	6791	8022	5321	8.888
	0 (Ground)									*12854	8996	*10095	6617	8269	5458	8.645
	-1.5															
	-3.0															
	-4.5															



- Notes:
- Ratings are based on ISO 10567
 - Lifting capacity does not exceed 75% of tipping load with the machine on firm, level ground or 87% full hydraulic capacity.
 - The load point is the centre-line of the bucket pivot mounting pin on the arm
 - * Indicates load limited by hydraulic capacity
 - 0 m= Ground

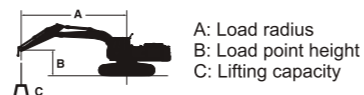

For lifting capacities, subtract bucket and quick hitch weight from lifting capacities without bucket.

EQUIPMENT

● Standard equipment ○ Optional equipment

ENGINE	
Air cleaner double filters	●
Auto idle system	●
Cartridge-type engine oil filter	●
Cartridge-type fuel pre-filter	●
Cartridge-type fuel main filter	●
Dry-type air filter with evacuator valve (with air filter restriction indicator)	●
ECO/PWR mode control	●
Fan guard	●
Water separator	●
Pre-cleaner	●
Dust-Proof indoor net	●
Radiator reserve tank	●
50 A alternator	●

HYDRAULIC SYSTEM	
Auto power lift	●
Control valve with main relief valve	●
Full-flow filter	●
High mesh full flow filter with restriction indicator	○
Pilot filter	●
Power boost	●
Suction filter	●
One extra port for control valve	●
Work mode selector	●

CAB	
All-weather sound suppressed steel cab	●
AM-FM radio with 2 speakers	●
Auto control air conditioner	●
Drink holder	●
Drink holder with hot & cool	●
Electric horn	●
Engine shut-off lever	●
Evacuation hammer	●
Floor mat	●
Footrest	●
Front window washer	●
Front windows on upper, lower and left side can be opened	●
Lower cab front guard	●
Upper cab front guard	●
Hot & cool box	●
Intermittent windshield wipers	●
Room light	●
Top guard Level I (ISO10262) compliant cab	●
Pilot control shut-off lever	●

Rear tray	●
Retractable seat belt	●
Rubber radio antenna	●
Seat : mechanical suspension seat	●
Seat adjustment part : backrest, armrest, height and angle, slide forward / back	●
Short wrist control levers	●
4 fluid-filled elastic mounts	●

MONITOR SYSTEM	
Meters : Hr meter, trip-meter, engine coolant temperature gauge and fuel gauge	●
Warning Lamps : Alternator charge, engine oil pressure, engine overheat, air filter restriction and minimum fuel level	●
Pilot lamps : Engine preheat, engine oil level, engine coolant level, hydraulic oil level, work light, auto-idle, and attachment mode	●
Alarm buzzers : Engine oil pressure and engine overheat	●

LIGHTS	
2 cab roof front lights	●
2 boom light	●
1 Tool Box light	●
Boom light cover	○

UPPER STRUCTURE	
Electric fuel refilling pump	●
Fuel level float	●
Hydraulic oil level gauge	●
Rear view mirror (right & left side)	●
Swing parking brake	●
Tool box	●
Undercover	●
Utility space	●
6 900 kg counterweight	●
7 600 kg counterweight	○
2 x 128 Ah batteries	●

UNDERCARRIAGE	
Bolt-on sprocket	●
Reinforced track links with pin seals	●
Travel motor covers	●
Travel parking brake	●
Track guard (each side) and hydraulic track adjuster	●
Upper and lower rollers	●
3 track guards	●
600 mm triple grouser shoes	●

FRONT ATTACHMENTS	
Welded bucket link A	●
Reinforced link B	●
Anti-drift valve for bucket	●
Dust seal on all bucket pins	●
Flanged pin	●
Reinforced resin thrust plate	●
1.3 m ³ bucket (ISO heaped)	●
Bucket (ISO heaped) 1.5/1.7/2.1 Cum	○
Block handling bucket	○
2.5 Cum coal bucket with 6m long Arm	○
6.40 m boom	●

ATTACHMENTS	
Attachment basic piping	●
Breaker piping	○
Parts for breaker	○
2 pump combined flow for attachment basic piping	○
Line filter	○

MISCELLANEOUS	
Lockable fuel refilling cap	●
Lockable machine covers	●
Onboard information controller	●
Skid-resistant tapes, plates and handrails	●
Standard tool kit	●
Travel direction mark on track frame	●
Global e-Service	●
Swing Alarm	○
Travel Alarm	○
OPG Top guard level - II	○
Fire extinguisher	○

OUR NETWORK

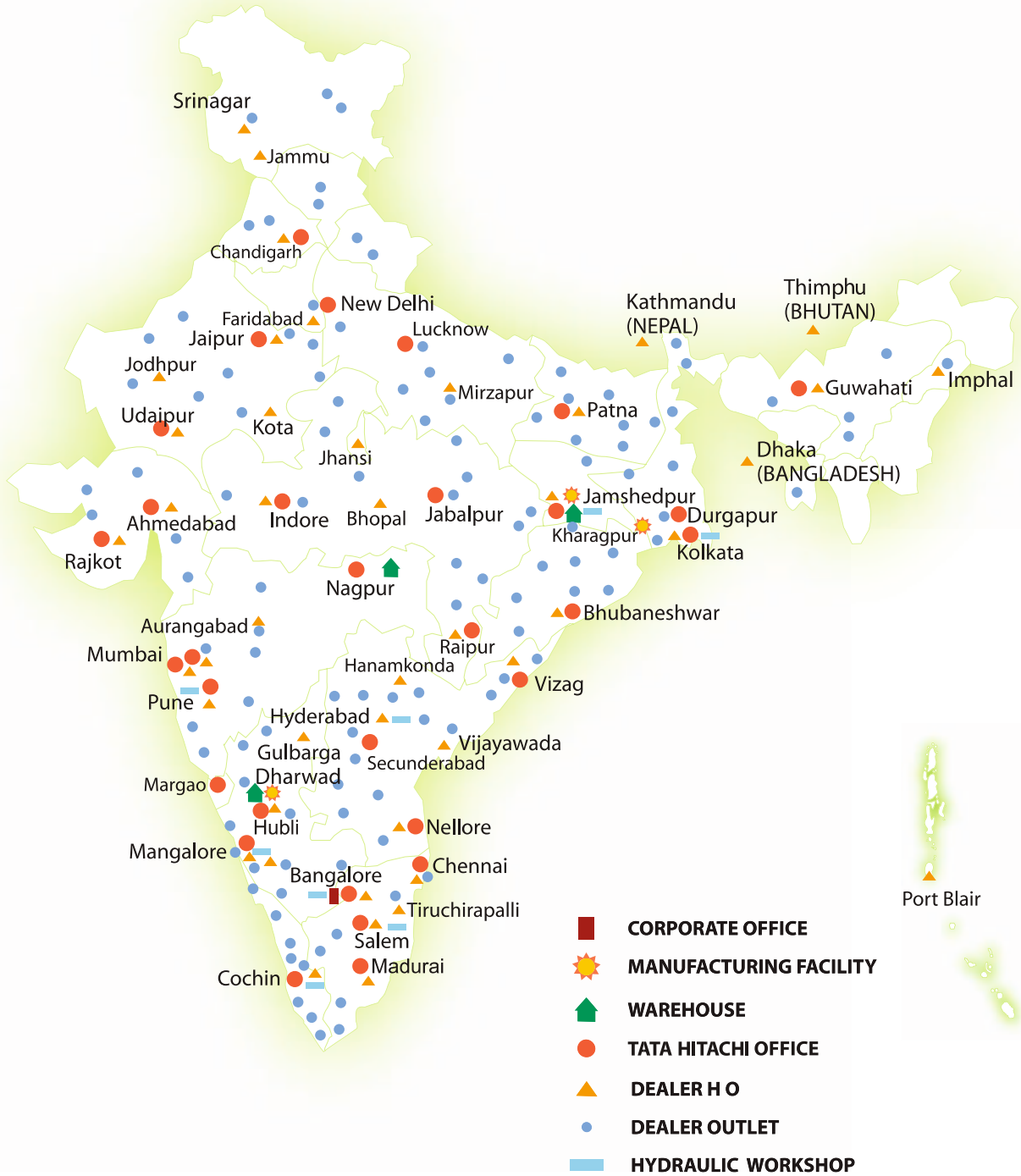

Tata Hitachi Construction Machinery Company Private Limited

Registered Office: Jubilee Building, 45 Museum Road, Bangalore, India 560025
 Telephone: +918066953301 / 02/03/04/05 | Email: info@tatahitachi.co.in

www.tatahitachi.co.in
Toll Free Number 1800 121 6633

OUR RANGE OF PRODUCTS

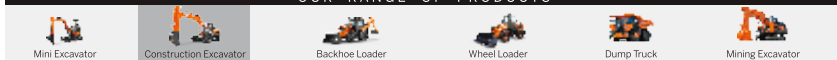

Authorised Dealer

These specifications are subject to change without prior notice. The machine depicted may vary from the actual machine. Please contact our nearest office for latest specifications. Accessories shown here are not part of the standard equipment. Performance of the machine may vary with site and operating conditions encountered.